

Pulse duration tunable and high-brightness unstable cavity microchip laser

Hwan Hong LIM

*Division of Research Innovation and Collaboration
Institute for Molecular Science (IMS)*

lim-hwanhong@ims.ac.jp

Outline

1. Introduction
2. Pulse duration tunable MCL
3. High brightness unstable cavity MCL
4. Summary

Introduction

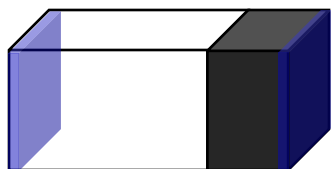

- ▶ Compact
- ▶ Stable
- ▶ Short pulse (< 1 ns) \rightarrow $>$ MW peak power
- ▶ Single axial frequency

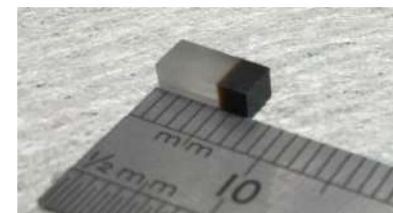

Fiber delivery laser

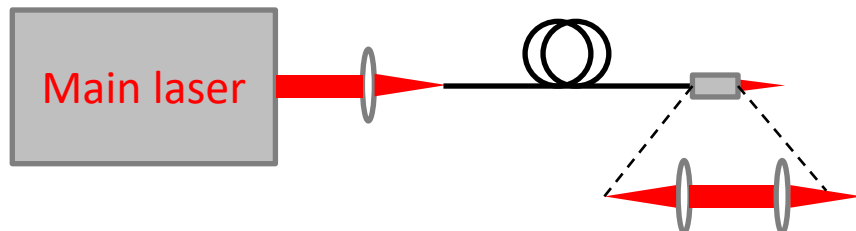

Microchip laser

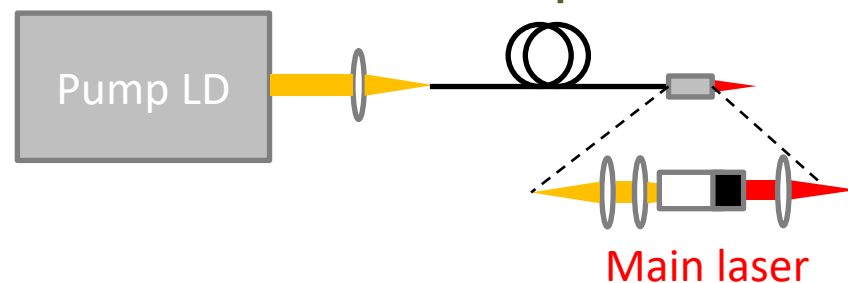

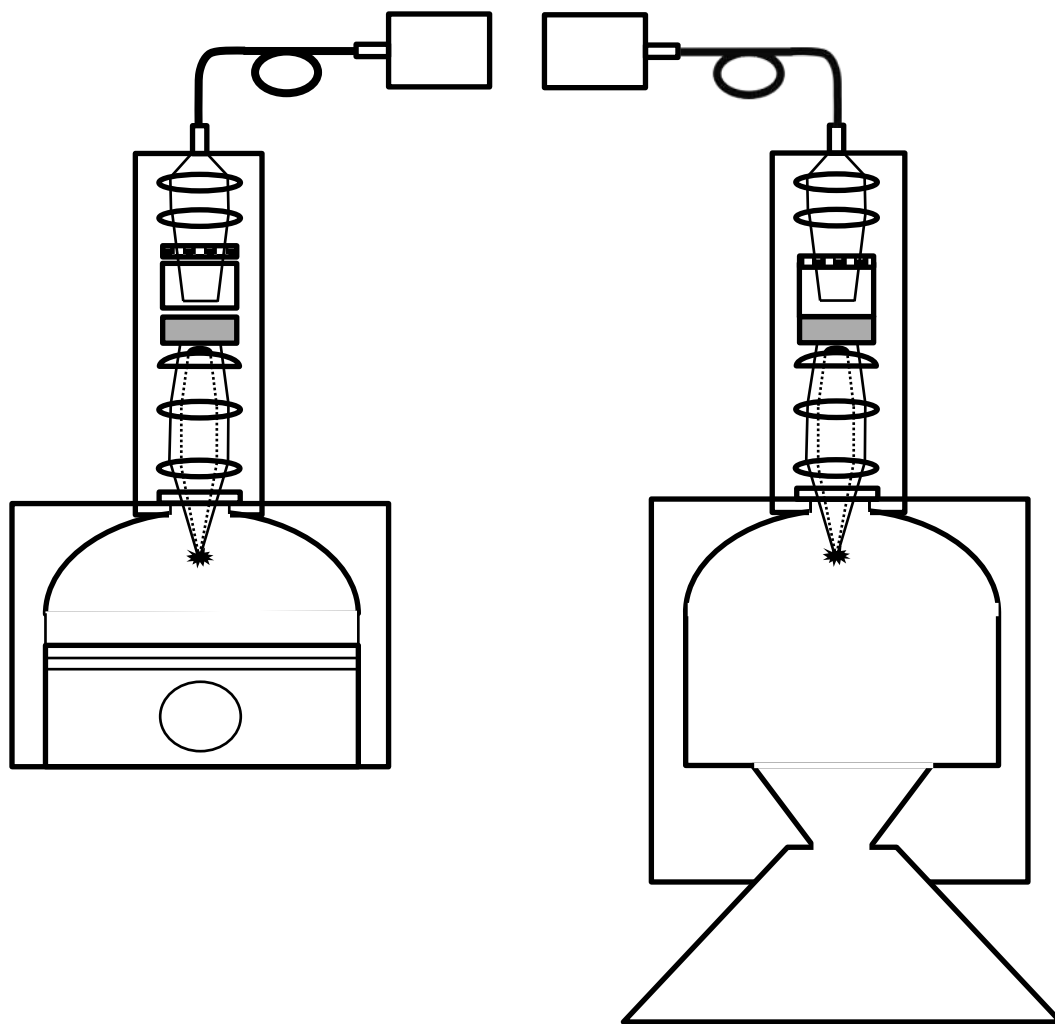

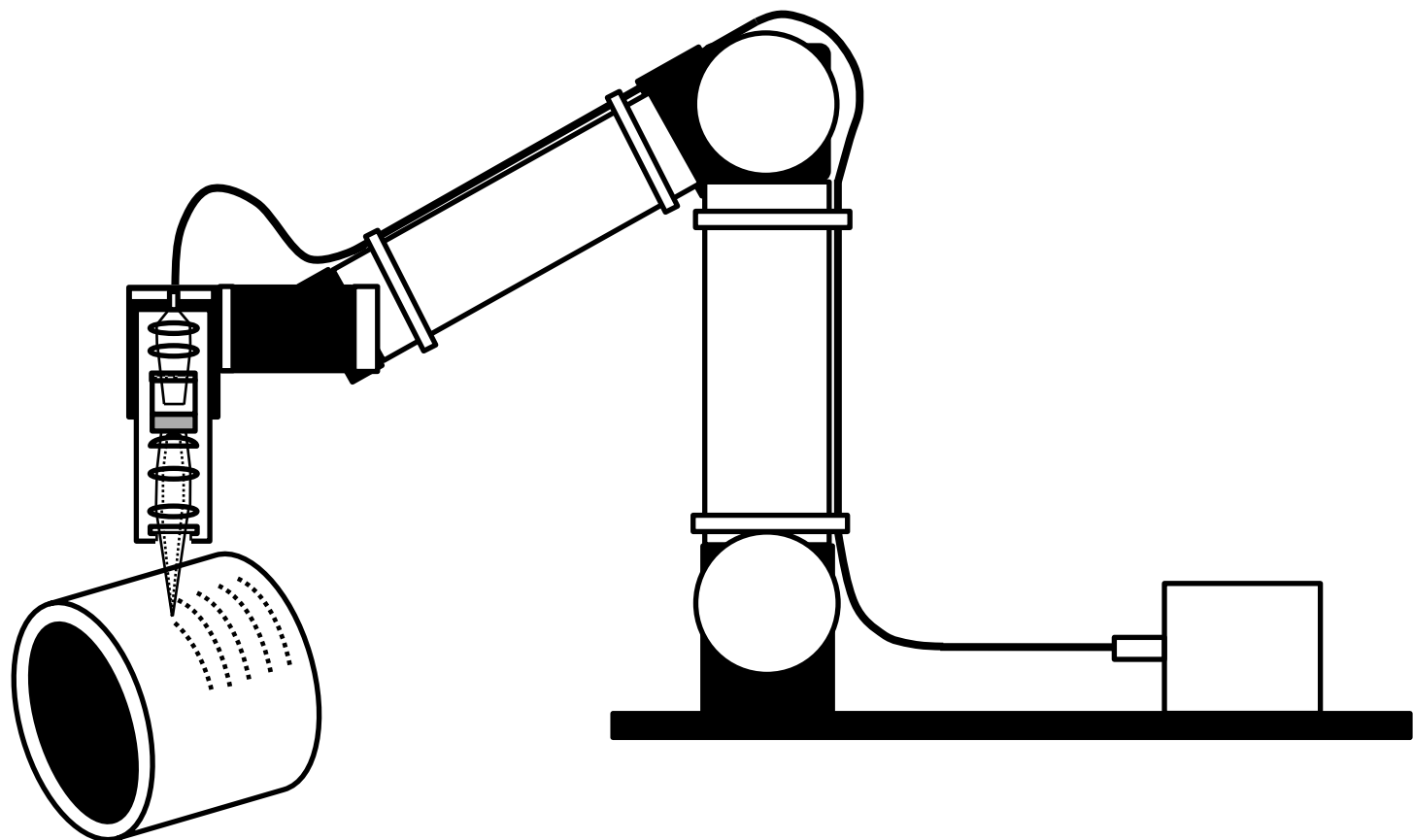

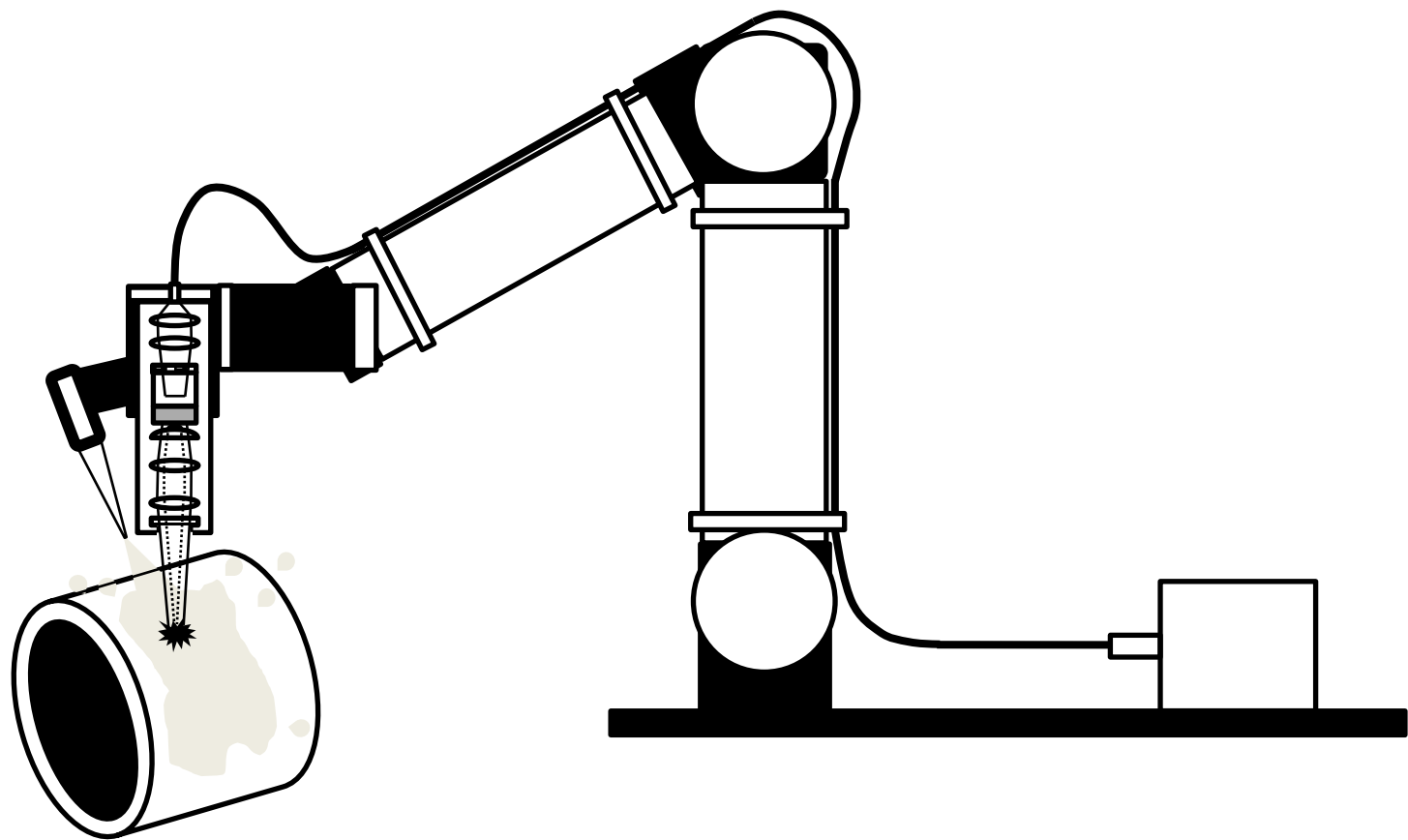

Spectrometer

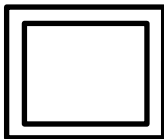

Laser diode

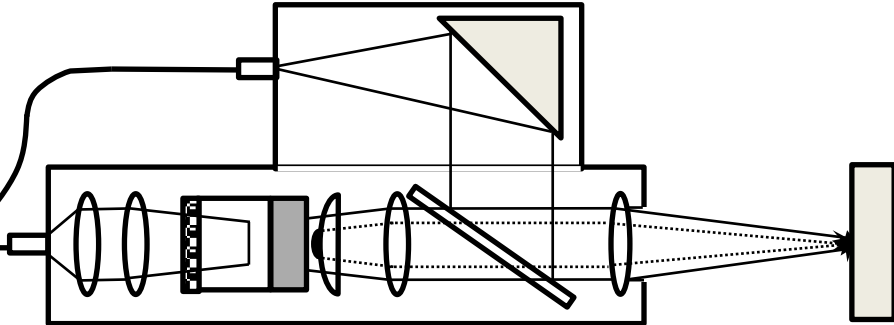
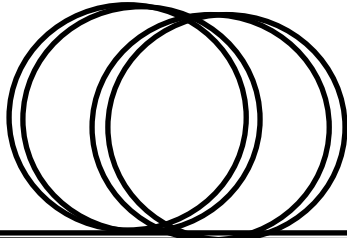

► Pulse broadening

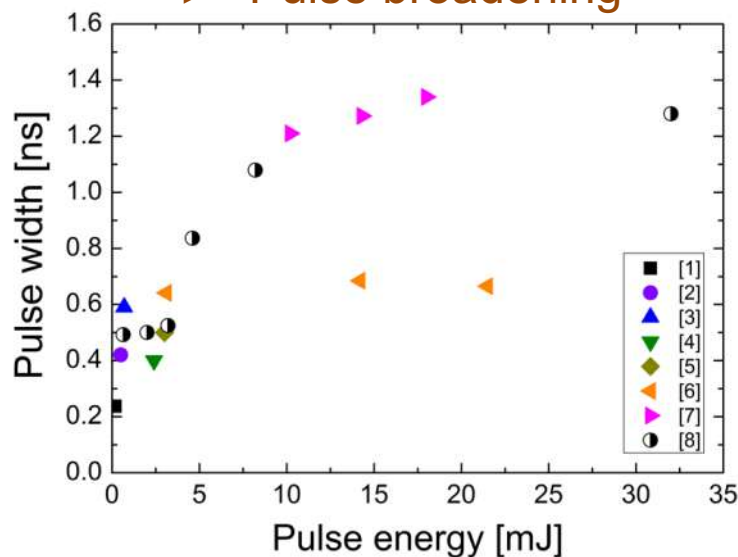

► M² degradation

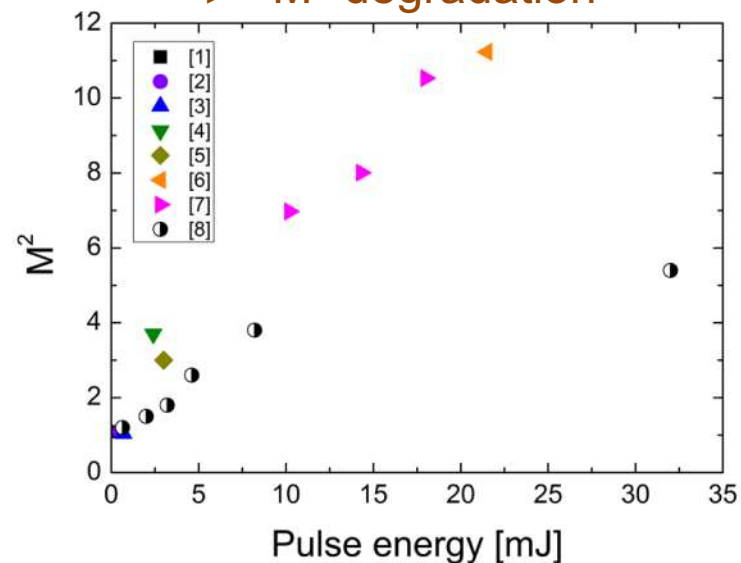

► Beam pattern degradation

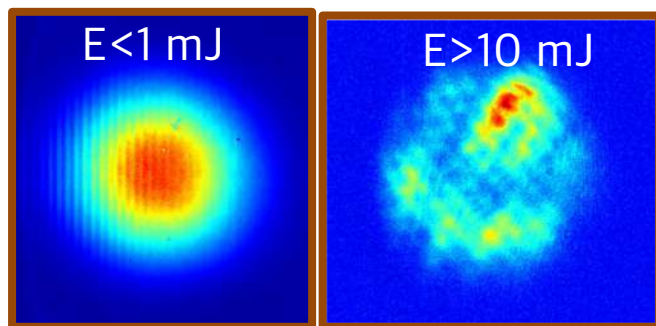

- [1] J. Dong, et al., Opt. Express **15**, 14516 (2007).
- [2] A. Agnesi, et al., Appl. Phys. Lett. **89**, 101120 (2006).
- [3] H. Sakai, et al., Opt. Express **16**, 19891 (2008).
- [4] N. Pavel, et al., Opt. Express **19**, 9378 (2011).
- [5] H. H. Lim and T. Taira, Opt. Express **25**, 6302 (2017).
- [6] L. Zheng, et al., Opt. Express **27**, 30217 (2019).
- [7] H. H. Lim and T. Taira, Opt. Express **27**, 31307 (2019).
- [8] X. Guo, et al., Opt. Express **27**, 45-54 (2019).

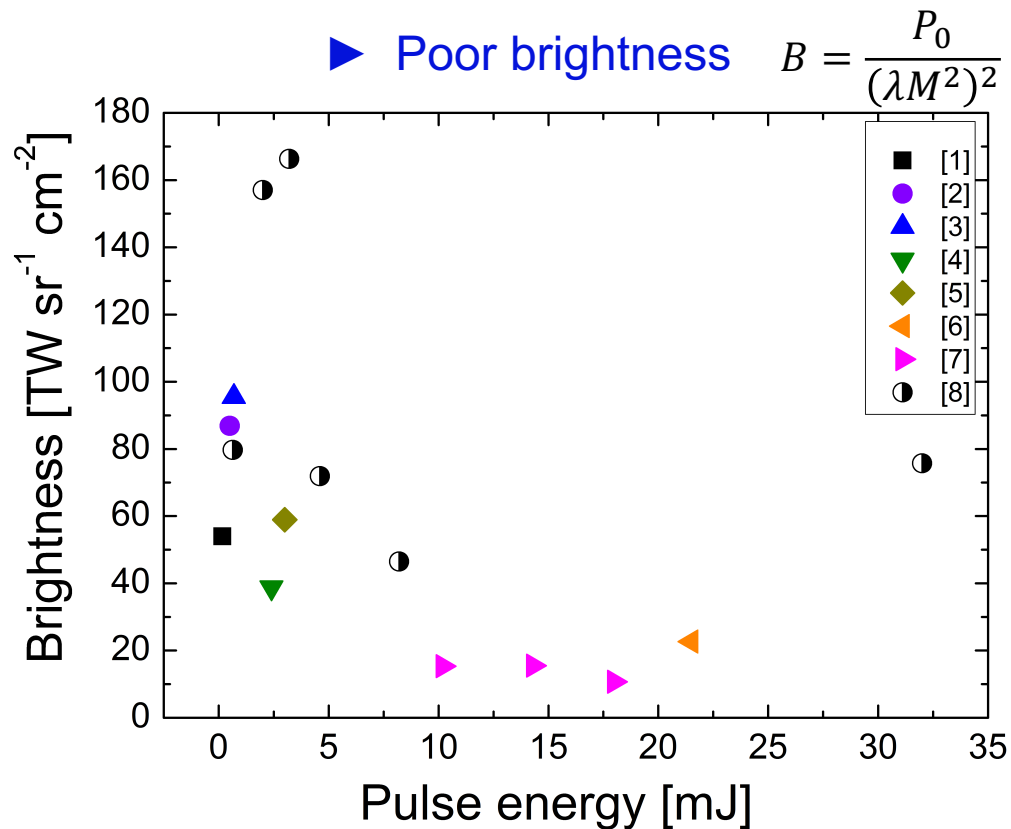

- [1] J. Dong, et al., Opt. Express **15**, 14516 (2007).
- [2] A. Agnesi, et al., Appl. Phys. Lett. **89**, 101120 (2006).
- [3] H. Sakai, et al., Opt. Express **16**, 19891 (2008).
- [4] N. Pavel, et al., Opt. Express **19**, 9378 (2011).
- [5] H. H. Lim and T. Taira, Opt. Express **25**, 6302 (2017).
- [6] L. Zheng, et al., Opt. Express **27**, 30217 (2019).
- [7] H. H. Lim and T. Taira, Opt. Express **27**, 31307 (2019).
- [8] X. Guo, et al., Opt. Express **27**, 45-54 (2019).

Pulse duration tunable laser

Nd:YAG/Cr:YAG ceramic
3 X 3 X 7 mm³

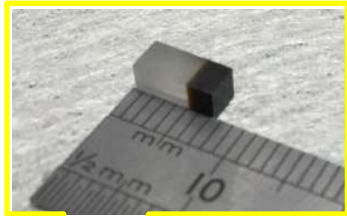

Q-switched pulse duration \propto cavity length

$$\tau_p \approx \frac{r\eta(r)}{r-1-\ln r} \tau_c$$

τ_c : the cavity lifetime

r : the initial inversion ratio

η : the energy extraction efficiency

Cavity length dependent characteristics

Pulse shape

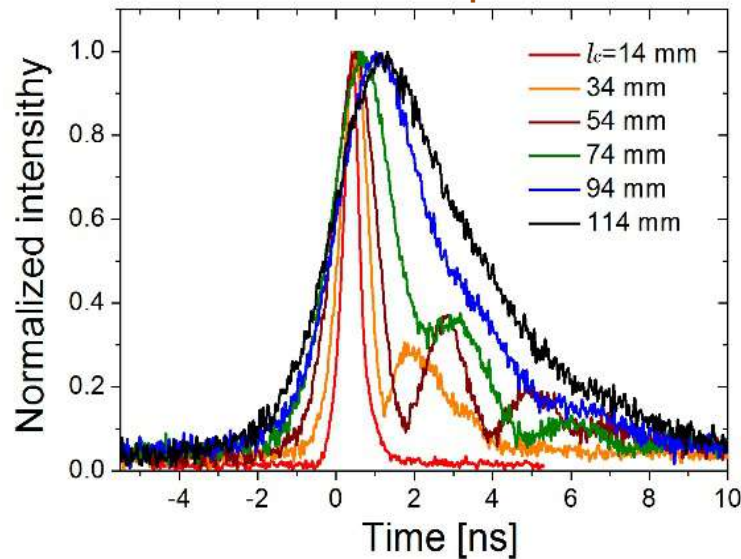

Beam pattern

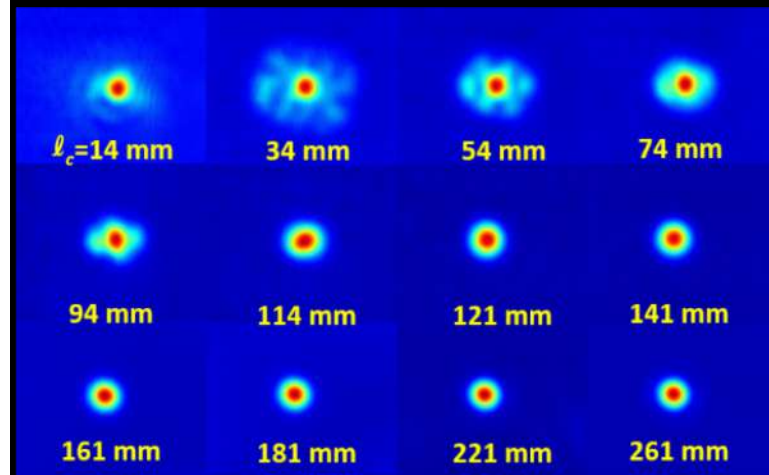

Pulse width tunable MOPA

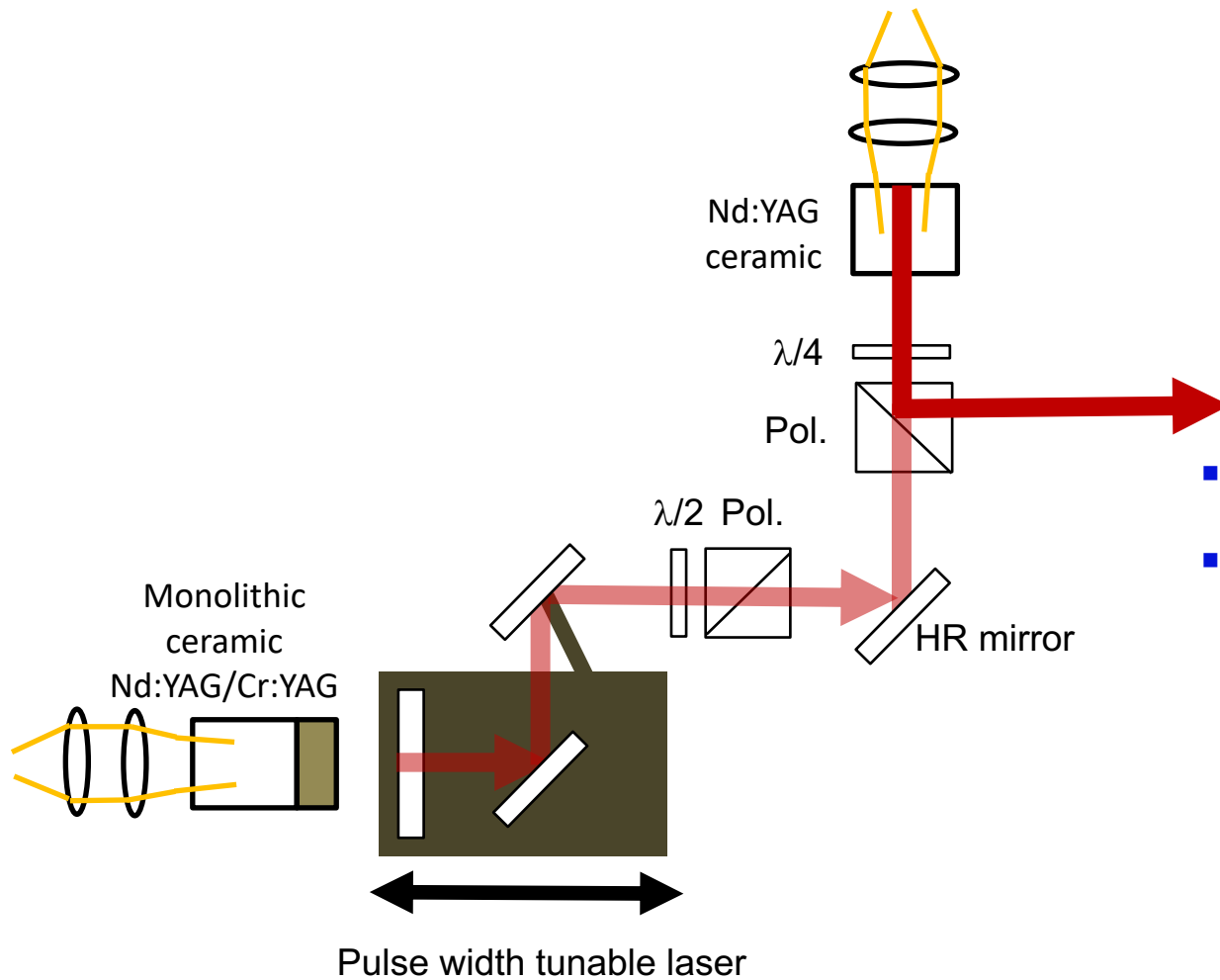

- >2 times energy amplification
- Beam quality improvement ($M^2=1.3$ for short cavities)

Application examples

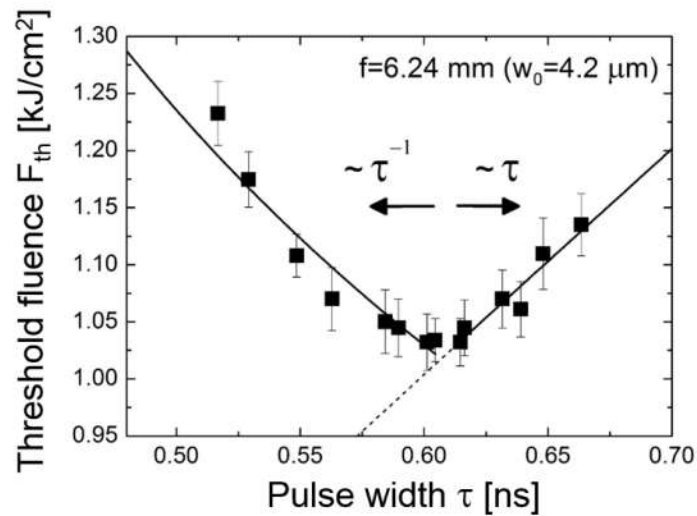

High brightness unstable cavity MCL

- ▶ Wider and controllable mode volumes
- ▶ Uniform beam pattern of doughnut shape
 - ▶ No beam pattern degradation for energy scaling
- ▶ A good focusability of doughnut beam as a Bessel-like beam

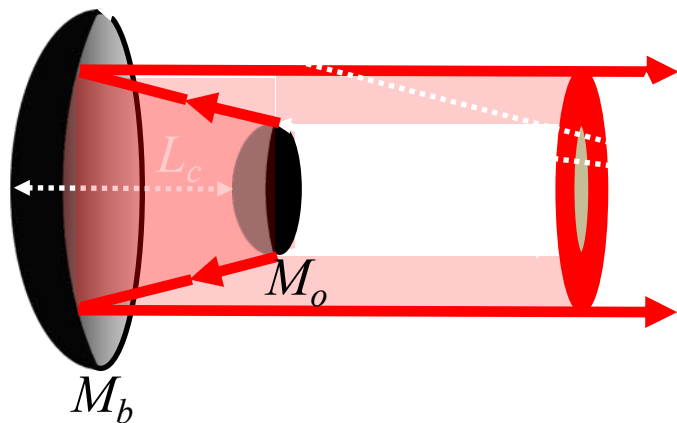
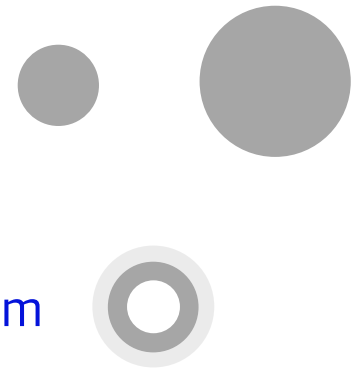

Positive branch confocal cavity

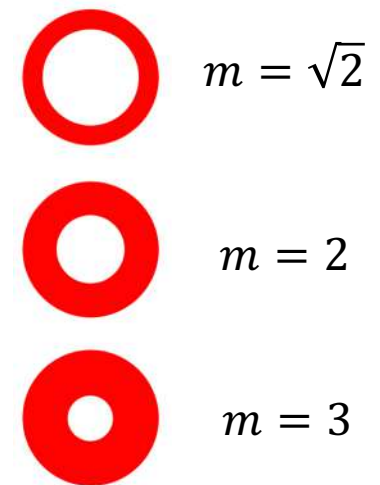

Experimental setup

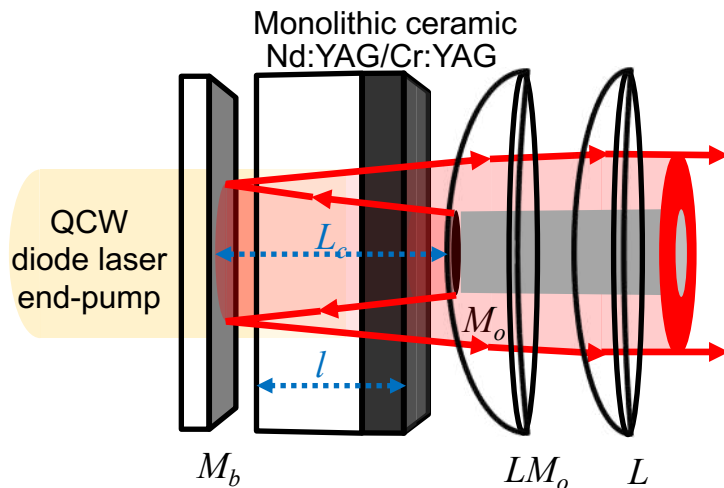

- ▶ 700 W pump diode @ 808 nm, 10 Hz during $<400 \mu\text{s}$
- ▶ Monolithic ceramic with a dimension of $6 \times 6 \times 7(l) \text{ mm}^3$
- ▶ 1.1 at.% Nd^{3+} doping and 30% of initial transmittance of $\text{Cr}^{4+}:\text{YAG}$

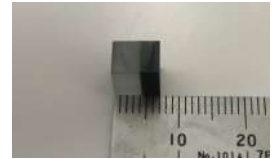

- ▶ Flat back cavity mirror M_b
- ▶ A half inch plano-convex lens LM_o with a radius of curvature of 52 mm (for m of $\sqrt{2}$ for the confocal cavity)
- ▶ Output coupler (OC) M_o , HR coated on the center part of LM_o in a spot diameter of 2 mm
- ▶ Collimation lens L with a focal length of 50~150 mm in case of the lens position

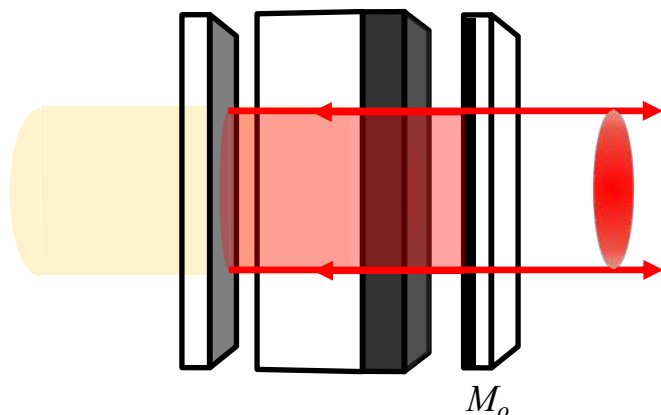

- ▶ Comparison of laser performance for brightness scaling
- ▶ Replacement of the curved OC, M_o with a flat mirror
- ▶ Identical all other conditions (pumping, cooling, and so on) for both resonators
- ▶ A flat mirror with a reflectance of 50% (the same round-trip loss for an ideal confocal cavity with m of $\sqrt{2}$)

Laser characteristics

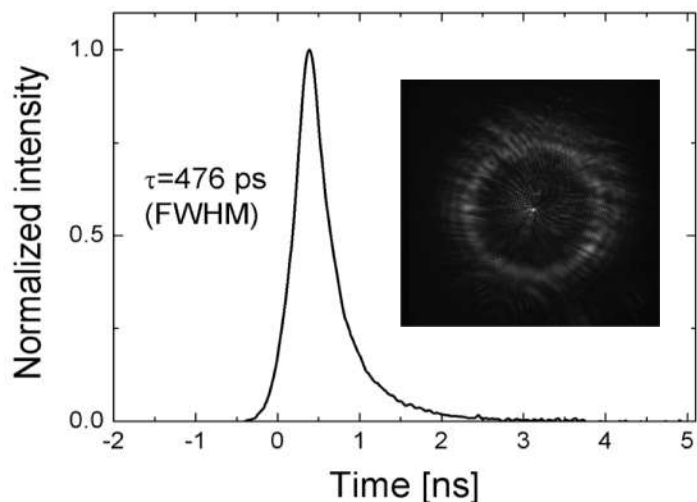

- ▶ Doughnut beam pattern with a center Poisson spot
- ▶ Pulse energy of 13.2 mJ @ 10 Hz
- ▶ Pulse width of 476 ps

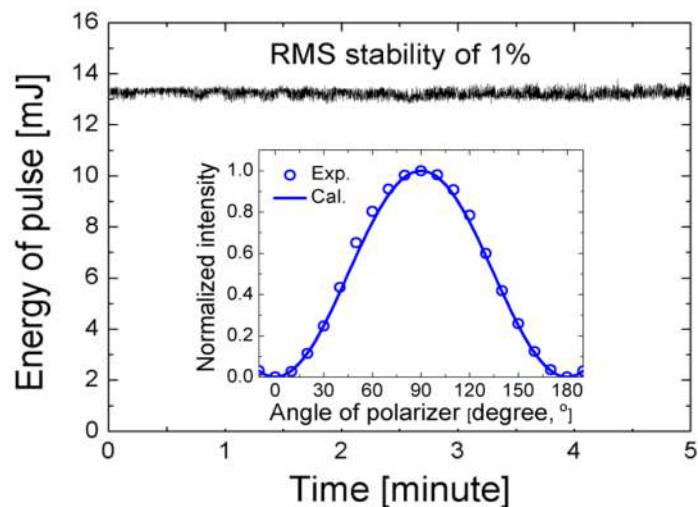

- ▶ Short term RMS stability <1%
- ▶ Linear polarization @ 10 Hz
(may be pump power induced birefringence and depolarization due to stress and heat)

Laser characteristics

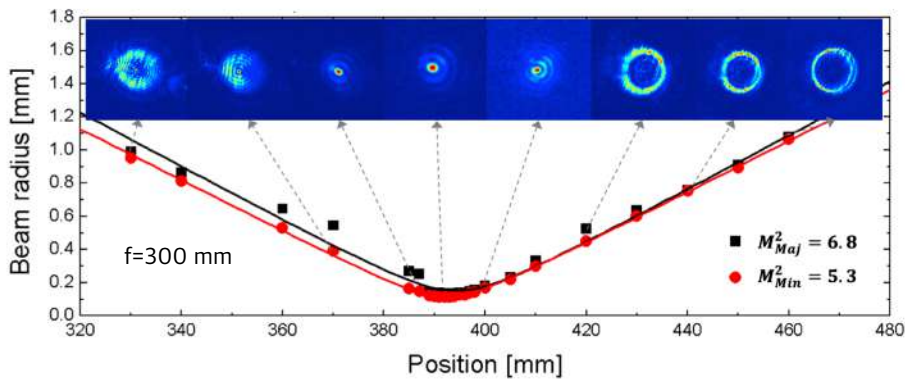

- ▶ second-moment based M^2 and 86.5% power-content based M_{pc}^2
- $$M_{ave}^2 = \sqrt{M_{maj}^2 M_{min}^2}$$

- ▶ The center part (red line) of Bessel-like beam has (black line).
- ▶ The small center part can increase focusability substantially.

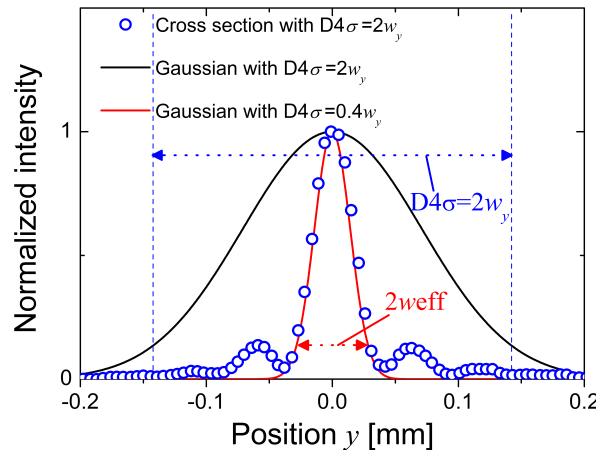

$$M_{eff}^2 = \frac{\pi w_{0,eff}}{\lambda} \theta = \frac{\pi w_{0,eff}}{\lambda} \cdot \frac{\lambda M^2}{\pi w_0} = \frac{w_{0,eff}}{w_0} M^2 = 0.2 \times 6 = 1.2.$$

M_{eff}^2 : effective M^2

$w_{0,eff}$: effective beam waist

θ : half angle divergence

Laser characteristics

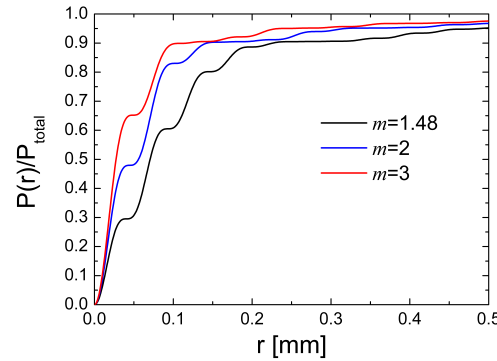
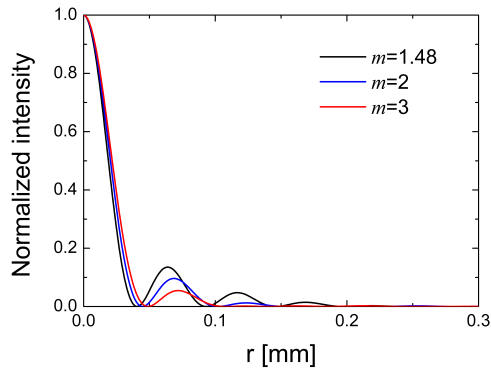

$E_{eff} \approx 30\%$

Intensity distribution of plane wave focused by an annular aperture at the focal plane

$$I(r, f) = \frac{4 I(0, f)}{(1 - 1/m^2)^2} \left[\frac{J_1(kr b/f)}{kr b/f} - \frac{1}{m^2} \frac{J_1(kr a/f)}{kr a/f} \right]^2, \quad (1)$$

where $m = b/a$ is the ratio of the outer radius b and the inner radius a of the aperture, $S = \pi a^2(m^2 - 1)$ is the annular area, J_1 is the first-order Bessel function, $k = 2\pi/\lambda$ is the wave number, f is the focal length, and $I(0, f) = S^2/(\lambda^2 f^2)$ is the peak intensity at the focal plane. [1] B. Lu, et al., J. Mod. Opt. **48**, 1171 (2001).

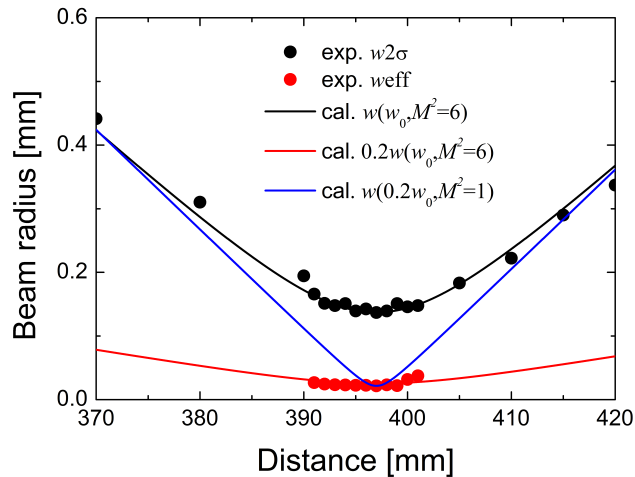

$Z_{R,eff}$
(Red line)

$Z_{R,G}(M^2=1)$
(Blue line)

Comparison with flat-flat cavity

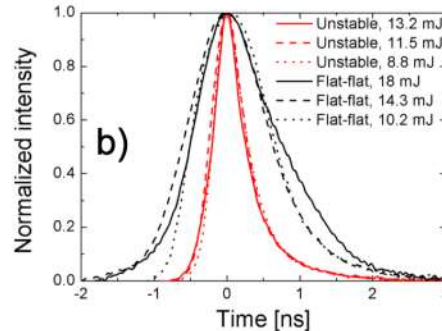
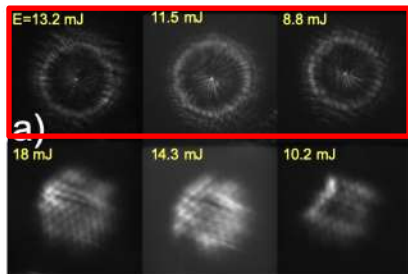

► The energies of 8.8, 11.5, and 13.2 mJ for unstable cavity are paired with 10.2, 14.3, and 18 mJ for flat-flat cavity by every pump condition, respectively.

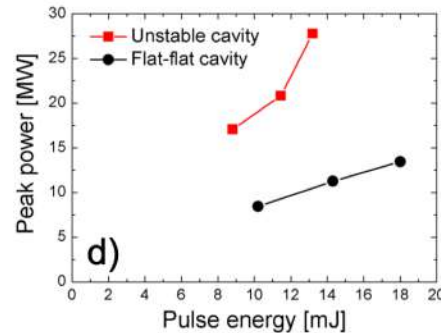
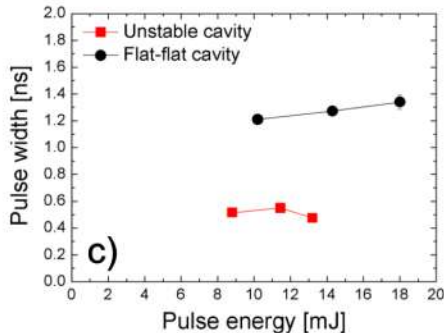

► No degradation of pulse width and M^2 due to the uniform doughnut pattern for energy scaling.

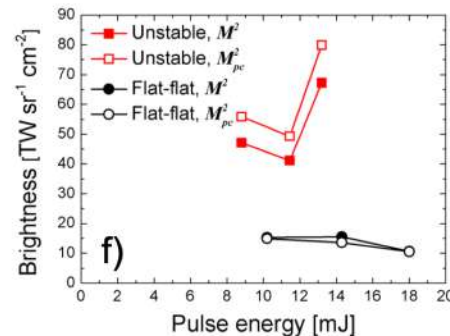
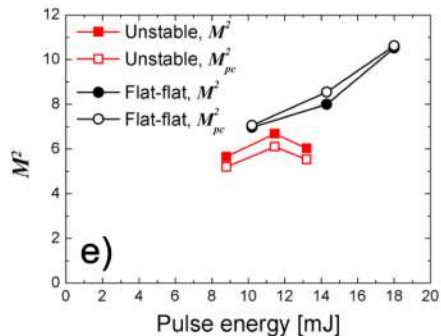

Comparison with other works

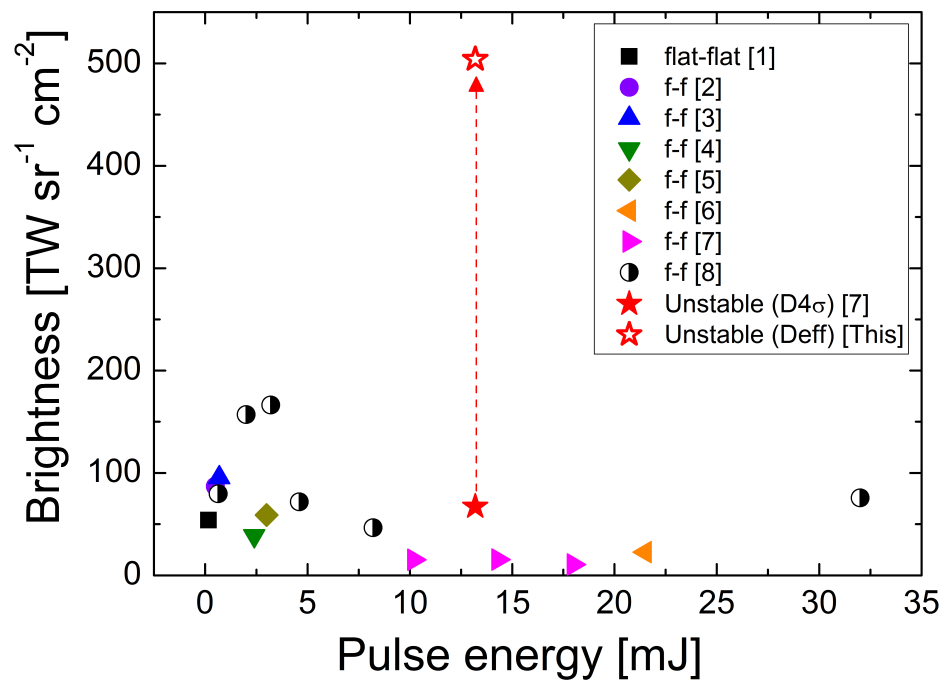

- [1] J. Dong, et al., Opt. Express **15**, 14516 (2007).
- [2] A. Agnesi, et al., App. Phys. Lett. **89**, 101120 (2006).
- [3] H. Sakai, et al., Opt. Express **16**, 19891 (2008).
- [4] N. Pavel, et al., Opt. Express **19**, 9378 (2011).
- [5] H. H. Lim and T. Taira, Opt. Express **25**, 6302 (2017).
- [6] L. Zheng, et al., Opt. Express **27**, 30217 (2019).
- [7] H. H. Lim and T. Taira, Opt. Express **27**, 31307 (2019).
- [8] X. Guo, et al., Opt. Express **27**, 45-54 (2019).

▶ $E_{eff} = 30\%$

▶ $M_{eff}^2 = 1.2$

▶ Highest effective brightness of over 0.5 PW/(sr·cm⁻²)

Laser induced breakdown (LIB) in air

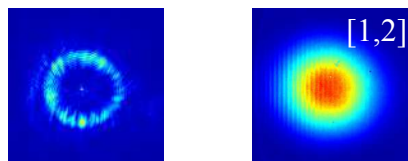
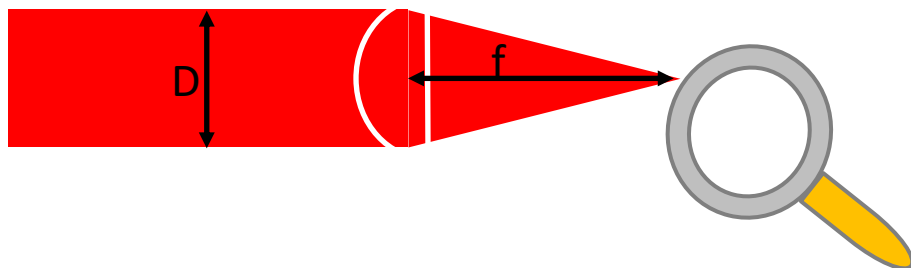

$D=7.5$ mm $D=7.5$ mm
 $\tau=0.57$ ns $\tau=0.57$ ns
 $M^2=$ $M^2=$

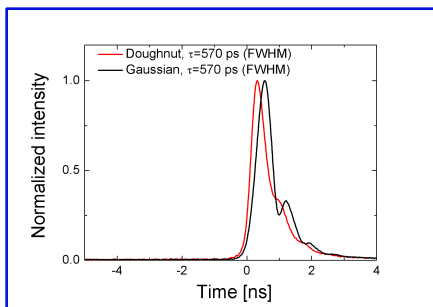
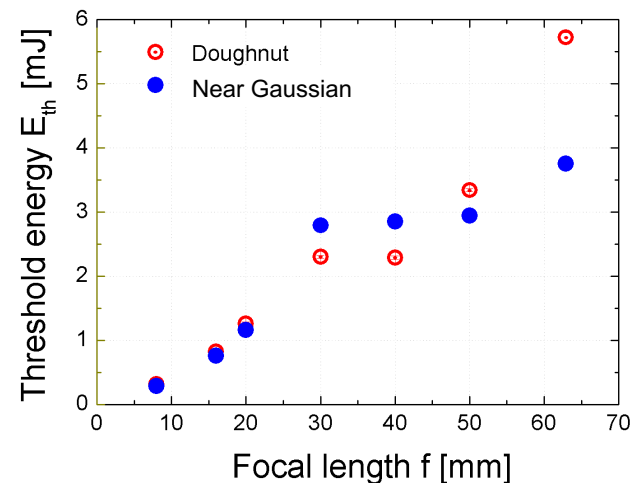

- [1] H. H. Lim and T. Taira, Opt. Express **25**, 6320 (2017).
 [2] H. H. Lim and T. Taira, Opt. Express **27**, 31307 (2019).

Application examples

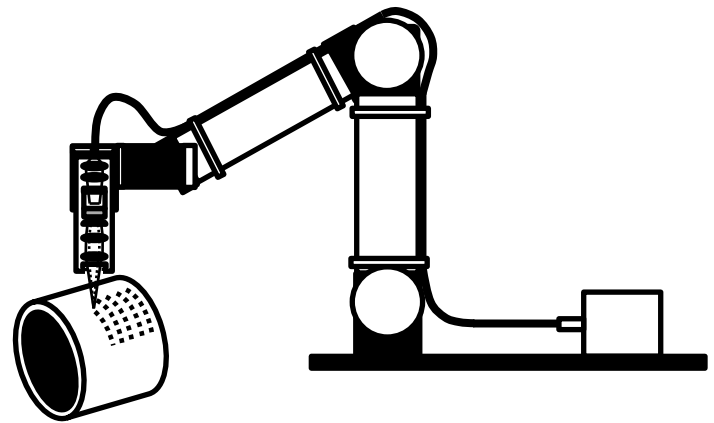
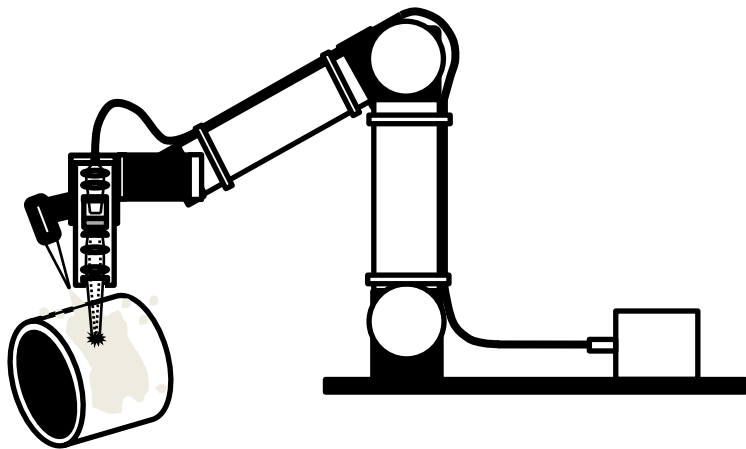

Summary

▶ Pulse duration tunable laser: 0.5-9 ns, ~1 MW

▶ High brightness doughnut laser: $0.5 \text{ sr}^{-1} \text{ cm}^{-2}$, 28 MW, 13.2 mJ

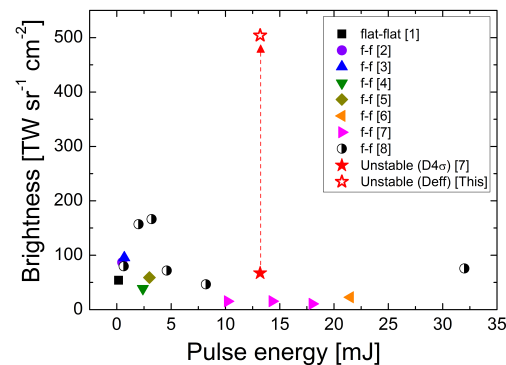
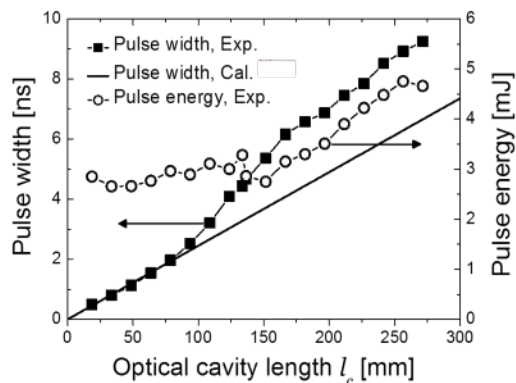
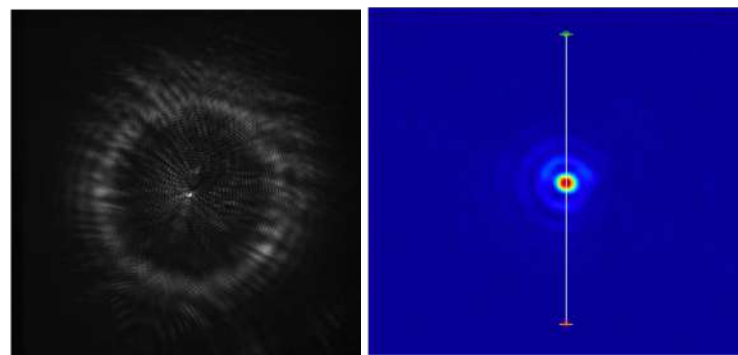
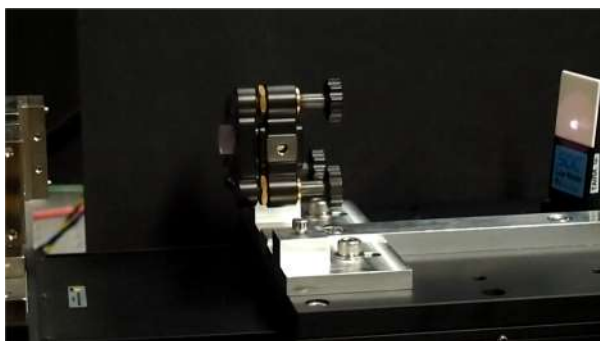

Future works

- ▶ Brightness scaling up
- ▶ Higher repetition rate
- ▶ Frequency conversion by NLO

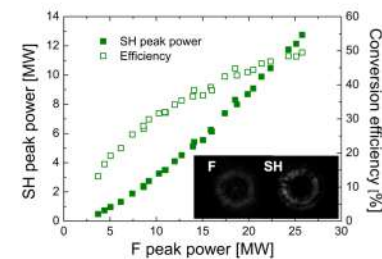
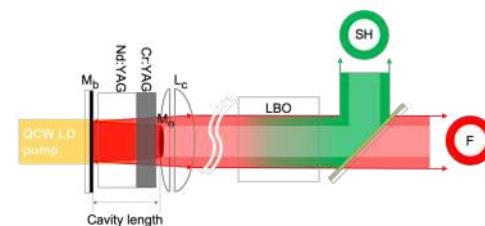
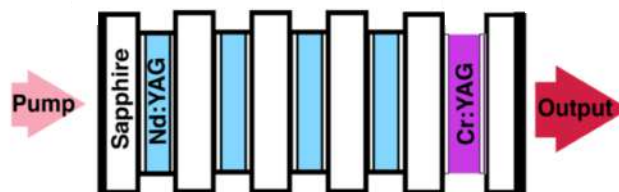
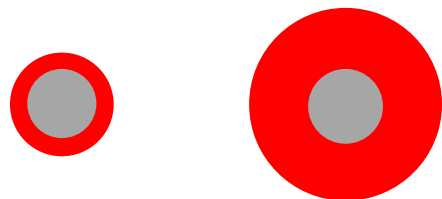

Acknowledgement

Support:



Impulsing Paradigm Change
through Disruptive Technologies Program

IMPACT



New Energy and Industrial Technology
Development Organization